

Workspace for business

SECURITY DOOR PANEL

Delivery and Production

MATERIALS FOR INTERIOR DESIGN
AND CONSTRUCTION MARKET

STUDIO SEGRETO

SERIE P PLANA

ALLUMINIO MULTISTRATO

MULTILAYER ALUMINIUM

Pannelli costituiti da una doppia anima flessibile. Adatti per l'esterno, vantano una struttura compatta e resistente.

CARATTERISTICHE

Con la nuova tecnologia e l'inserimento della doppia anima flessibile, oltre a migliorare incredibilmente le prestazioni, questo prodotto innovativo sul mercato consente di controllare la dilatazione termica derivante dall'irraggiamento nella parte esterna. Inoltre, grazie all'inserimento della seconda anima flessibile permette di controllare la dilatazione interna dovuta alla forte escursione termica tra la temperatura interna (ambiente riscaldato) e la temperatura esterna, soprattutto nei periodi invernali e in zone con forte escursione tra giorno e notte.

INSERTI IN ALLUMINIO

Questo sistema permette di connettere diverse lamiere fra loro, mantenendo la perfetta planarità della superficie esterna e valorizzando il tutto con un inserto in alluminio. In aggiunta c'è la possibilità di personalizzare al massimo la propria porta e di scegliere anche il tipo di inserto a vista se 10 o 2 mm e la relativa finitura.

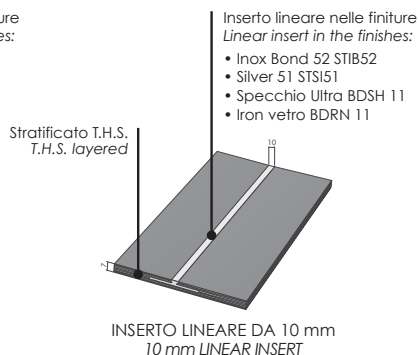
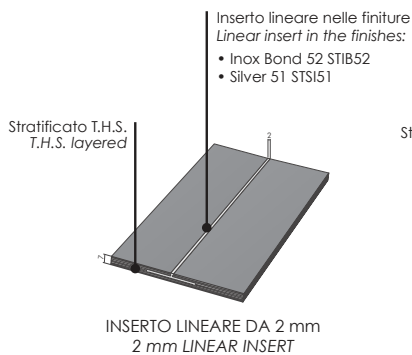

Panels made out of a double core panel. Suitable for the exterior, they boast a compact and resistant structure.

STRUCTURAL FEATURES

Its new technology and its flexible double core enhance its own performances and allows a better control of the thermal expansion due to the sunlight irradiation of its outward side. Furthermore, the inward side expansion, due to the thermal difference between outside and inside temperature, mainly during winter time and in particular areas with high day-night temperature excursion, can be controlled thanks to the second flexible core.

ALUMINIUM INSERTS

The best solutions that allows the connection between the panels, keeping the perfect planarity of the outside panel, enhanced with a special aluminum insert. Highly customized by choosing from the range of the aluminum insert decoration (from 10 to 2 mm thickness) and the several coatings.

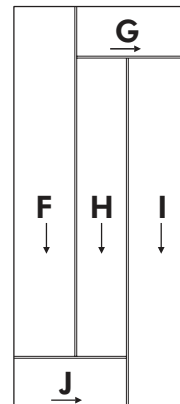

PERSONALIZZA LA PORTA SCEGLIENDO I COLORI DELLE FASCE (A, B, C,...). VEDI A PAG 24
CUSTOMIZE THE DOOR BY CHOOSING THE COLOURS OF THE BANDS (A, B, C,...) ON PAGE 24

SERIE P PLANA
Alluminio Multistrato
Multilayer aluminium

* Insetti Inox Bond 52 - codice FM0 S
 Inox Bond 52 insert - code FM0 S



MOD. pl Holon SX 1538
 Fascia centrale: Inox Bond 52 - STIB52
 Fasce laterali: Castagno 41 - UBSC41
 Insetto lineare da 10 mm *
 Central band: Inox Bond 52 - STIB52
 Lateral bands: Chestnut 41 - UBSC41
 10 mm linear insert *



MOD. pm Holon dx 1539
 Fascia centrale: Inox Bond 52 - STIB52
 Fasce laterali: Castagno 41 - UBSC41
 Insetto lineare da 10 mm *
 Central band: Inox Bond 52 - STIB52
 Lateral bands: Chestnut 41 - UBSC41
 10 mm linear insert *



MOD. pn Moma 1531
 Laccato RAL 3005 e RAL 3007
 Insetto lineare da 10 mm *
 Lacquered RAL 3005 and RAL 3007
 10 mm linear insert *



MOD. pp Melbourne 1536
 Fascia centrale: Grigio Tungsteno Ultra - BDTG11
 Fasce laterali: Grigio polvere - M7000
 Insetto lineare da 10 mm *
 Central band: Ultra tungsten grey - BDTG11
 Lateral bands: Dusty grey - M7000
 10 mm linear insert *

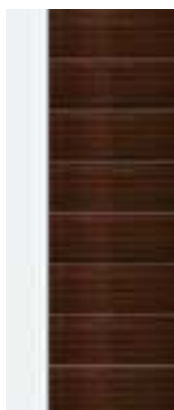

MOD. pq Cantù sx 1529
 Fascia laterale sinistra: Laccato RAL 9003
 Fasce orizzontali: Legno Wenge 11
 Insetto lineare da 10 mm *
 Left lateral band: Lacquered RAL 9003
 Horizontal bands: Wood Wenge 11
 10 mm linear insert *

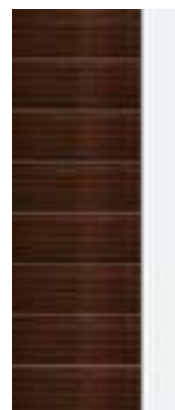

MOD. pr Cantù dx 1530
 Fascia laterale destra: Laccato RAL 9003
 Fasce orizzontali: Legno Wenge 11
 Insetto lineare da 10 mm *
 Right lateral band: Lacquered RAL 9003
 Horizontal bands: Wood Wenge 11
 10 mm linear insert *



MOD. pj Bijou sx 1533
 Fascia laterale sinistra: Specchio Ultra - BDSH11
 Fasce orizzontali: Marrone Polvere M7002
 Insetto lineare da 10 mm *
 Left lateral band: Ultra mirror - BDSH11
 Horizontal bands: Dusty brown M7002
 10 mm linear insert *



MOD. pk Bijou dx 1534
 Fascia laterale destra: Specchio Ultra - BDSH11
 Fasce orizzontali: Marrone Polvere M7002
 Insetto lineare da 10 mm *
 Right lateral band: Ultra mirror - BDSH11
 Horizontal bands: Dusty brown M7002
 10 mm linear insert *



MOD. qn Ermitage 1519
 Fascia centrale: Iron Ultra - BDRN11
 Fasce esterne: Grigio Ardesia Ultra - BDGR11
 Insetto lineare da 10 mm *
 Central band: Iron Ultra - BDRN11
 External bands: Ultra slate grey - BDGR11
 10 mm linear insert *

SERIE P PLANA
Alluminio Multistrato
Multilayer aluminium



MOD. ph PITTI DX 1525

Fascia centrale: Iron Ultra - BDRN11
 Fasce esterne: Grigio Ardesia Ultra - BDGR11
 Insetto lineare da 10 mm *
 Central band: Iron Ultra - BDRN11
 External bands: Ultra slate grey - BDGR11
 10 mm linear insert *



MOD. pi PITTI SX 1527

Fascia centrale: Iron Ultra - BDRN11
 Fasce esterne: Grigio Ardesia Ultra - BDGR11
 Insetto lineare da 10 mm *
 Central band: Iron Ultra - BDRN11
 External bands: Ultra slate grey - BDGR11
 10 mm linear insert *



MOD. ps LINO 1535

Fascia centrale: Bianco - UBBI24
 Fasce esterne: Rovere 44 - UBGV44
 Insetto lineare da 10 mm *
 Central band: White - UBBI24
 External bands: Oak 44 - UBGV44
 10 mm linear insert *



MOD. po ALBO 1523

Fascia centrale: Uberall 21 - UBRN21
 Fasce esterne: Uberall 21 - UBRN21
 Insetto lineare da 10 mm *
 Central band: Uberall 21 - UBRN21
 External bands: Uberall 21 - UBRN21
 10 mm linear insert *



MOD. qr Dalmine 1532

Fascia centrale: Grigio polvere - M7000
 Fasce laterali: Grigio Tungsteno Ultra - BDTG11
 Insetto lineare da 10 mm *
 Central band: Dust grey - M7000
 Lateral bands: Ultra tungsten grey - BDTG11
 10 mm linear insert *



MOD. qs Flou 1537

Laccato RAL 3005 e RAL 3007
 Insetto lineare da 10 mm *
 Lacquered RAL 3005 and RAL 3007
 10 mm linear insert *

SERIE P

Alluminio Base MDF | Allutermico Base Poliuretano

MDF-based aluminium | Polyurethane foam-based thermal aluminium



Sleek Sentry 1 mod. ℓm Leincester 510, laccato RAL 8003
Sleek Sentry 1 mod. ℓm Leincester 510, lacquered RAL 8003

SERIE P

ALLUMINIO | ALLUTERMICO

BASE MDF BASE POLIURETANO ESPANSO

ALUMINIUM | THERMAL ALUMINIUM
MDF-BASED POLYURETHANE FOAM-BASED

Pannelli costituiti da un doppio foglio in alluminio e da un'intercapedine di supporto. Adatti per l'esterno, vantano una struttura compatta e resistente, caratterizzata da una notevole durata nel tempo. Disponibile in numerosi colori RAL e finiture tinto legno.

Panels made out of a double aluminum sheet and an interspace support. Suitable for the exterior, they boast a compact and resistant structure, offering remarkable duration in time. Available in numerous RAL colors and wood-stained finishes.

CARATTERISTICHE ALLUMINIO BASE MDF

STRUTTURA

Il rivestimento è realizzato in mdf isolante supportato in alluminio grezzo sul lato inferiore ed in alluminio bugnato sul lato superiore

LACCATURA

Il pannello da rivestimento può essere sottoposto a laccatura uniforme. La finitura può essere "lucida" oppure "opaca".

FINITURA LEGNO

Il pannello di rivestimento in alluminio può avere finitura finto legno.

CARATTERISTICHE ALLUTERMICO BASE POLIURETANO ESPANSO

STRUTTURA

Il rivestimento è realizzato in poliuretano espanso supportato in alluminio grezzo sul lato inferiore ed in alluminio bugnato sul lato superiore

LACCATURA

Il pannello di rivestimento è sottoposto a laccatura uniforme. La finitura è del tipo "opaco". Fattibile anche in finitura lucida.

FINITURA LEGNO

Il pannello di rivestimento è sottoposto a finitura verniciato tinta legno.

STRUCTURAL ALUMINIUM MDF-BASED

STRUCTURE

The panelling is made of insulating MDF supported by a rough profile on the lower side and by a light alloy on the upper side.

LACQUERING

The panelling undergoes an evening lacquering. The finish is matt.

WOOD FINISH

The panelling undergoes a faux wood finishing.

STRUCTURAL THERMAL ALUMINIUM POLYURETHANE FOAM-BASED

STRUCTURE

The panelling is made of expanded polyurethane supported with raw aluminium on the lower side and in textured aluminium on the upper side.

LACQUERING

The panelling undergoes an evening lacquering. The finish is matt and feasible also in the glossy finish.

WOOD FINISH

The panelling undergoes wood colour painted finishing.

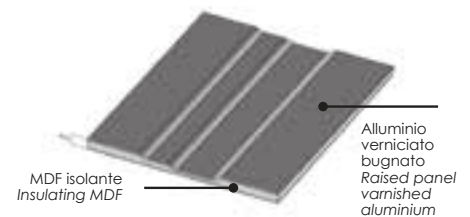

ALLUMINIO BASE MDF / ALUMINIUM MDF-BASED

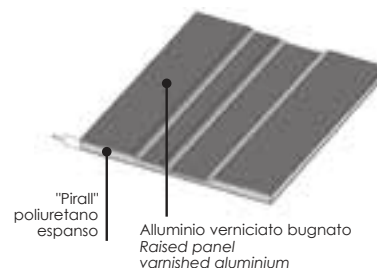

ALLUTERMICO BASE POLIURETANO ESPANSO
THERMAL ALUMINIUM
POLYURETHANE FOAM-BASED

SERIE P

Alluminio Base MDF | Allutermico Base Poliuretano

MDF-based aluminium | Polyurethane foam-based thermal aluminium



Finitura sublimata
Sublimation



Finitura anodizzata
Anodizing

SERIE P

Alluminio Base MDF | Allutermico Base Poliuretano

MDF-based aluminium | Polyurethane foam-based thermal aluminium



MOD. la Arsenal 100 alluminio/aluminium
MOD. ma Arsenal 100 allutermico / thermal alum.
Laccato RAL 7031 / Lacquered RAL 7031



MOD. lb Oxford 530 alluminio/aluminium
MOD. mb Oxford 530 allutermico / thermal alum.
Laccato RAL 7030 / Lacquered RAL 7030



MOD. lc Montparnasse 750 alluminio/aluminium
MOD. mc Montparnasse 750 allutermico / thermal alum.
Laccato RAL 1013 / Lacquered RAL 1013



MOD. ld Regent 770 alluminio/aluminium
MOD. md Regent 770 allutermico/thermal alum.
Laccato RAL 7031 / Lacquered RAL 7031



MOD. le Madison 780 alluminio/aluminium
MOD. me Madison 780 allutermico/thermal alum.
Laccato RAL 7030 / Lacquered RAL 7030



MOD. lf Piccadilly 850 alluminio/aluminium
MOD. mf Piccadilly 850 allutermico/thermal alum.
Laccato RAL 1013 / Lacquered RAL 1013



MOD. lg Carnaby 900 alluminio/aluminium
MOD. mg Carnaby 900 allutermico/thermal alum.
Laccato RAL 7031 / Lacquered RAL 7031



MOD. lh Aston 301 alluminio/aluminium
MOD. mh Aston 301 allutermico/thermal alum.
Laccato RAL 7030 / Lacquered RAL 7030



MOD. li Bolton 302 alluminio/aluminium
MOD. mi Bolton 302 allutermico/thermal alum.
Laccato RAL 1013 / Lacquered RAL 1013

SERIE P

Alluminio Base MDF | Allutermico Base Poliuretano

MDF-based aluminium | Polyurethane foam-based thermal aluminium



MOD. lj West 322 alluminio/aluminium
MOD. mj West 322 allutermico/thermal aluminium
Laccato RAL 6017 / Lacquered RAL 6017



MOD. lk Bastiglia 490 alluminio/aluminium
MOD. mk Bastiglia 490 allutermico/thermal aluminium
Laccato RAL 6009 / Lacquered RAL 6009

SERIE P

Alluminio Base MDF | Allutermico Base Poliuretano

MDF-based aluminium | Polyurethane foam-based thermal aluminium



MOD. lv Kenton 121 alluminio/aluminium
MOD. mv Kenton 121 allutermico/thermal alum.
Laccato RAL 7032 / Lacquered RAL 7032



MOD. lm Leincester 510 alluminio/aluminium
MOD. mm Leincester 510 allutermico/thermal alum.
Laccato RAL 7033 / Lacquered RAL 7033

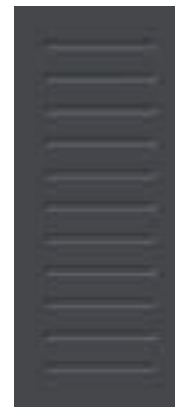

MOD. ln Houston 511 alluminio/aluminium
MOD. mn Houston 511 allutermico/thermal alum.
Laccato RAL 7024 / Lacquered RAL 7032

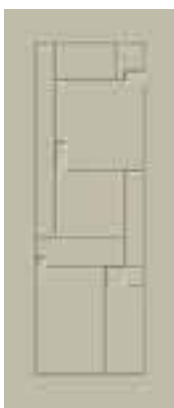

MOD. lo Russel 540 alluminio/aluminium
MOD. mo Russel 540 allutermico/thermal alum.
Laccato RAL 7032 / Lacquered RAL 7032



MOD. lp Harlem 560 alluminio/aluminium
MOD. mp Harlem 560 allutermico/thermal alum.
Laccato RAL 7033 / Lacquered RAL 7033



MOD. lq Cascais 580 alluminio/aluminium
MOD. mq Cascais 580 allutermico/thermal alum.
Laccato RAL 7024 / Lacquered RAL 7032



MOD. lr Vosges 594 alluminio/aluminium
MOD. mr Vosges 594 allutermico/thermal alum.
Laccato RAL 7032 / Lacquered RAL 7032



MOD. ls Cardiff 790 alluminio/aluminium
MOD. ms Cardiff 790 allutermico/thermal alum.
Laccato RAL 7033 / Lacquered RAL 7033



MOD. lt Precox 1010 alluminio/aluminium
MOD. mt Precox 1010 allutermico/thermal alum.
Laccato RAL 7024 / Lacquered RAL 7032

SERIE P

Alluminio Base MDF | Allutermico Base Poliuretano

MDF-based aluminium | Polyurethane foam-based thermal aluminium



MOD. ll Kenton 120 alluminio/aluminium

MOD. ml Kenton 120 allutermico/thermal aluminium

Laccato RAL 5007 / Lacquered RAL 5007



MOD. lu Precox 1011 alluminio/aluminium

MOD. mu Precox 1011 allutermico/thermal aluminium

Laccato RAL 5007 / Lacquered RAL 5007

SERIE P

Alluminio Base MDF | Allutermico Base Poliuretano

MDF-based aluminium | Polyurethane foam-based thermal aluminium



MOD. lw Network 1020 alluminio/aluminium
MOD. mw Network 1020 allutermico/thermal alum.
Laccato RAL 7047 / Lacquered RAL 7047



MOD. lx Network 1021 alluminio/aluminium
MOD. mx Network 1021 allutermico/thermal alum.
Laccato RAL 7047 / Lacquered RAL 7047



MOD. ly Display 1030 alluminio/aluminium
MOD. my Display 1030 allutermico/thermal alum.
Laccato RAL 7036 / Lacquered RAL 7036



MOD. lz Web 1060 alluminio/aluminium
MOD. mz Web 1060 allutermico/thermal alum.
Laccato RAL 6028 / Lacquered RAL 6028



MOD. na Web 1061 alluminio/aluminium
MOD. oa Web 1061 allutermico/thermal alum.
Laccato RAL 6028 / Lacquered RAL 6028



MOD. nb Bit 1070 alluminio/aluminium
MOD. ob Bit 1070 allutermico/thermal alum.
Laccato RAL 6028 / Lacquered RAL 6028



MOD. nc Bit 1071 alluminio/aluminium
MOD. oc Bit 1071 allutermico/thermal alum.
Laccato RAL 1014 / Lacquered RAL 1014



MOD. nd Bios 1080 alluminio/aluminium
MOD. od Bios 1080 allutermico/thermal alum.
Laccato RAL 1000 / Lacquered RAL 1000



MOD. ne Bios 1081 alluminio/aluminium
MOD. oe Bios 1081 allutermico/thermal alum.
Laccato RAL 1000 / Lacquered RAL 1000

SERIE P

Alluminio Base MDF | Allutermico Base Poliuretano

MDF-based aluminium | Polyurethane foam-based thermal aluminium



MOD. nf Wembley 1040 alluminio/aluminium
MOD. of Wembley 1040 allutermico/thermal alum.
Laccato RAL 9017 / Lacquered RAL 9017



MOD. ng Kennington 160 alluminio/aluminium
MOD. og Kennington 160 allutermico/thermal alum.
Laccato RAL 9018 / Lacquered RAL 9018



MOD. nh Rio 300 alluminio/aluminium
MOD. oh Rio 300 allutermico/thermal alum.
Laccato RAL 9002 / Lacquered RAL 9002



MOD. ni Ramblas 400 alluminio/aluminium
MOD. oi Ramblas 400 allutermico/thermal alum.
Laccato RAL 9016 / Lacquered RAL 9016



MOD. nj Soho 450 alluminio/aluminium
MOD. oj Soho 450 allutermico/thermal alum.
Laccato RAL 9016 / Lacquered RAL 9016



MOD. qp Darwen 141 alluminio/aluminium
MOD. qq Darwen 141 allutermico/thermal alum.
Laccato RAL 9016 / Lacquered RAL 9016



MOD. nk Soho 451 alluminio/aluminium
MOD. ok Soho 451 allutermico/thermal alum.
Laccato RAL 7037 / Lacquered RAL 7037



MOD. pu Liscio 1090 alluminio/aluminium
MOD. qu Liscio 1090 allutermico/thermal alum.
Laccato RAL 5014 / Lacquered RAL 5014

SERIE P

Alluminio Base MDF | Allutermico Base Poliuretano

MDF-based aluminium | Polyurethane foam-based thermal aluminium



MOD. no Cardusio 1107 alluminio/aluminium
MOD. oo Cardusio 1107 allutermico/thermal alum.
Laccato RAL 6025 / Lacquered RAL 6025



MOD. nq Mitte 1113 alluminio/aluminium
MOD. oq Mitte 1113 allutermico/thermal alum.
Laccato RAL 6020 / Lacquered RAL 6020



MOD. nr Samarcanda 1114 alluminio/aluminium
MOD. or Samarcanda 1114 allutermico/thermal alum.
Laccato RAL 6021 / Lacquered RAL 6021



MOD. nℓ Babila 1102 alluminio/aluminium
MOD. oℓ Babila 1102 allutermico/thermal alum.
Laccato RAL 7044 / Lacquered RAL 7044



MOD. nm Clotilde 1103 alluminio/aluminium
MOD. om Clotilde 1103 allutermico/thermal alum.
Laccato RAL 7006 / Lacquered RAL 7006



MOD. nn Greenwich 1106 alluminio/aluminium
MOD. on Greenwich 1106 allutermico/thermal alum.
Laccato RAL 6025 / Lacquered RAL 6025

SERIE P

Alluminio Base MDF | Allutermico Base Poliuretano

MDF-based aluminium | Polyurethane foam-based thermal aluminium

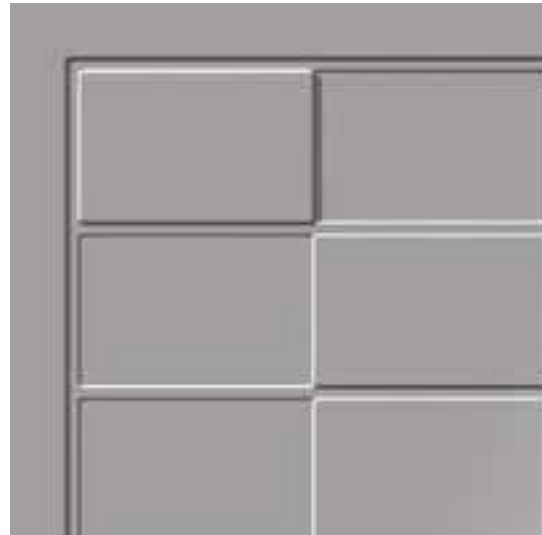

MOD. np Darling 1112 alluminio/aluminium
MOD. op Darling 1112 allutermico/thermal alum.
Laccato RAL 7036 / Lacquered RAL 7036

SERIE P

Alluminio Base MDF | Allutermico Base Poliuretano

MDF-based aluminium | Polyurethane foam-based thermal aluminium

SCEGLI LA FINITURA

SELECT THE FINISH



STAROX Blu Respiro 62
STAROX Blu Respiro 62

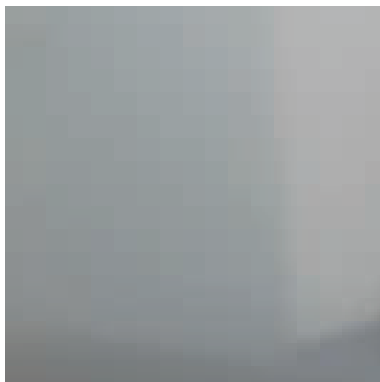

STAROX Grigio Fly 51
STAROX Grigio Fly 51



STAROX Inox Blond 52
STAROX Inox Blond 52

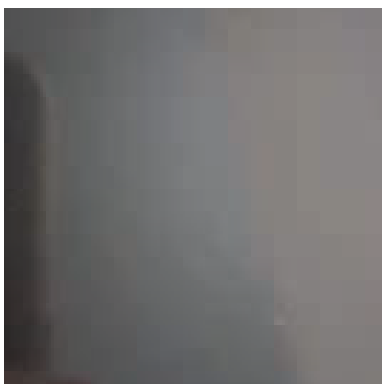

STAROX Night 51
STAROX Night 51

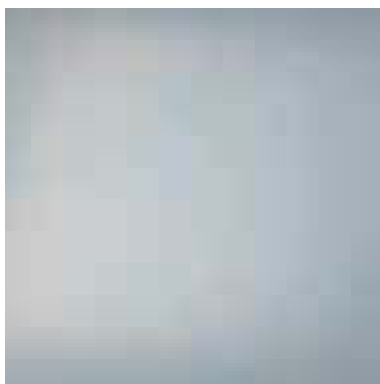

STAROX Silver 51
STAROX Silver 51



BRASED Amaranto Ultra
BRASED Amaranto Ultra



BRASED Grigio Ardesia Ultra
BRASED Grigio Ardesia Ultra



BRASED Grigio Tungsteno Ultra
BRASED Grigio Tungsteno Ultra

SCEGLI LA FINITURA

SELECT THE FINISH



BRASED Iron Ultra
BRASED Iron Ultra



BRASED Ruggine Ultra
BRASED Ruggine Ultra



BRASED Specchio Ultra
BRASED Specchio Ultra

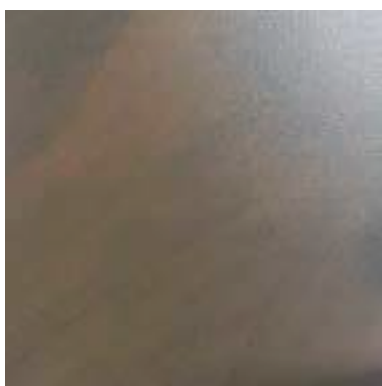

VERTEX Corten 11
VERTEX Corten 11



VERTEX Corten 12
VERTEX Corten 12



UBERALL Bianco 24
UBERALL Bianco 24



UBERALL Ciliegio 42
UBERALL Ciliegio 42



UBERALL Castagno 41
UBERALL Castagno 41

SERIE P

Alluminio Base MDF | Allutermico Base Poliuretano

MDF-based aluminium | Polyurethane foam-based thermal aluminium

SCEGLI LA FINITURA

SELECT THE FINISH



UBERALL Douglas 31
UBERALL Douglas 31



UBERALL Noce 41
UBERALL Noce 41



UBERALL Noce 43
UBERALL Noce 43



UBERALL 11
UBERALL 11



UBERALL 21
UBERALL 21



UBERALL HD Rovere 25
UBERALL HD Rovere 25

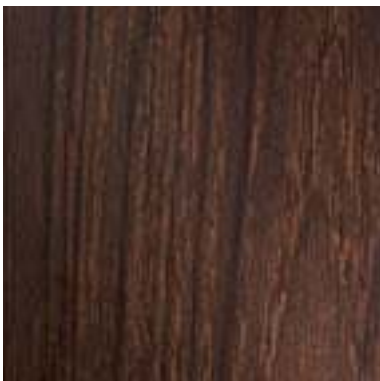

UBERALL HD Rovere 35
UBERALL HD Rovere 35



UBERALL Rovere 44
UBERALL Rovere 44



UBERALL Wengé 11
UBERALL Wengé 11

SERIE P

Alluminio Base MDF | Allutermico Base Poliuretano

MDF-based aluminium | Polyurethane foam-based thermal aluminium

SCEGLI LA FINITURA

SELECT THE FINISH



POLYCROM Grigio Polvere
POLYCROM Grigio Polvere



POLYCROM Marrone Povere
POLYCROM Marrone Povere



POLYCROM Verde Polvere
POLYCROM Verde Polvere



Colori RAL a scelta
Choice of RAL

SERIE P PLANA

Alluminio Multistrato

Multilayer aluminium

SOLO PER I RIVESTIMENTI PLANA
PERSONALIZZA LA PORTA SCEGLIENDO:
I COLORI DELLE FASCE (A, B, C,...)
E LO SPESSORE (2 o 10)
E LA FINITURA DELL'INSERTO

INOX BOND 52 STIB52
SILVER 51 STS151
SPECCHIO ULTRA BDSH11
IRON ULTRA BDRN11

ONLY FOR THE PLANA PANELLING,
CUSTOMIZE THE DOOR BY CHOOSING
THE COLOURS OF THE BANDS(A, B, C,...),
THE THICKNESS (2 or 10)
AND THE FINISHING OF THE INSERT

INOX BOND 52 STIB52
SILVER 51 STS151
SPECCHIO ULTRA BDSH11
IRON ULTRA BDRN11

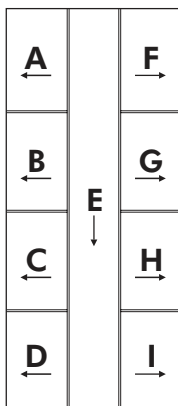

MOD. pp Melbourne 1536

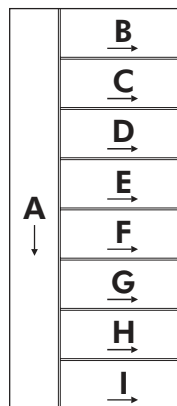

MOD. pq Cantù sx 1529

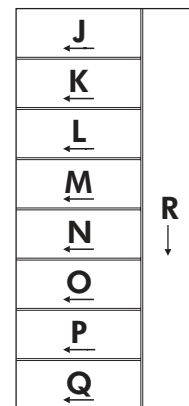

MOD. pr Cantù dx 1530

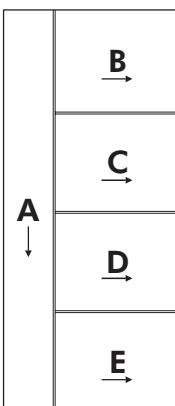

MOD. pj Bijou sx 1533

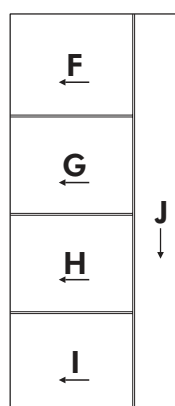

MOD. pk Bijou dx 1534

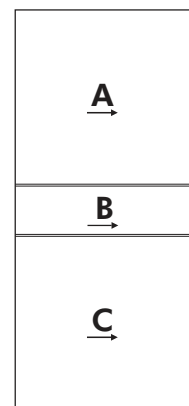

MOD. qn Ermitage 1519

SERIE P PLANA
Alluminio Multistrato
Multilayer aluminium

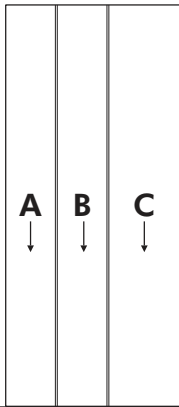

MOD. pl Holon SX 1538

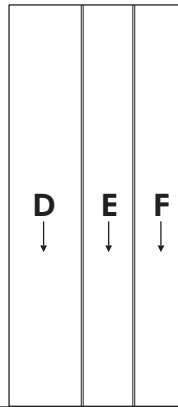

MOD. pm Holon dx 1539

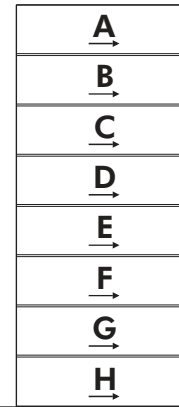

MOD. pn Moma 1531

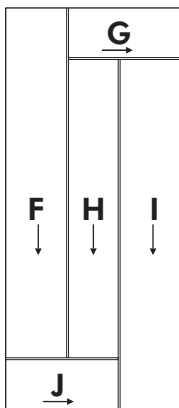

MOD. ph PITTI DX 1525

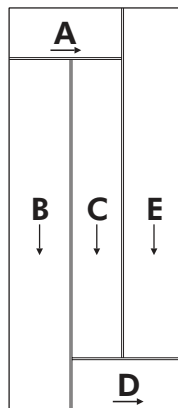

MOD. pi PITTI SX 1527

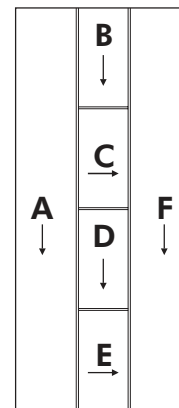

MOD. ps LINO 1535

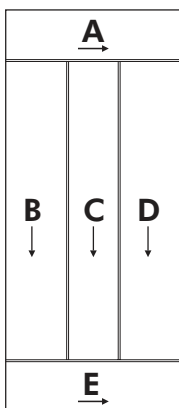

MOD. po ALBO 1523

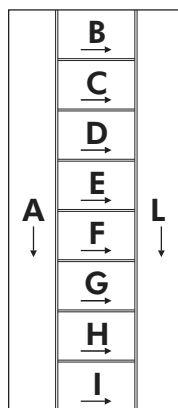

MOD. qr Dalmine 1532

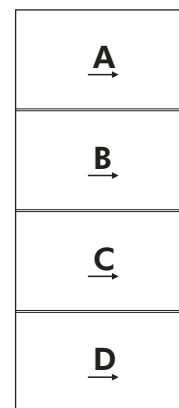

MOD. qs Flou 1537

SERIE R

Alluminio Base MDF | Allutermico Base Poliuretano

MDF-based aluminium | Polyurethane foam-based thermal aluminium



Sentry 1 mod. QQ Mira K, laccato RAL 7001
Sentry 1 mod. QQ Mira K, lacquered RAL 7001

SERIE R

ALLUMINIO | ALLUTERMICO

BASE MDF

BASE POLIURETANO ESPANSO

ALUMINIUM | THERMAL ALUMINIUM

MDF-BASED

POLYURETHANE FOAM-BASED

Pannelli costituiti da un doppio foglio in alluminio e da un'intercapedine di supporto. Adatti per l'esterno, vantano una struttura compatta e resistente, caratterizzata da una notevole durata nel tempo. Disponibile in numerosi colori RAL e finiture tinto legno.

CARATTERISTICHE ALLUMINIO BASE MDF

STRUTTURA

Il rivestimento è realizzato in mdf isolante supportato in alluminio grezzo sul lato inferiore ed in alluminio bugnato sul lato superiore.

LACCATURA

Il pannello di rivestimento è sottoposto a laccatura uniformante. La finitura è del tipo "lucido" oppure "opaco".

FINITURA LEGNO

Il pannello di rivestimento è sottoposto a finitura legno

CARATTERISTICHE ALLUTERMICO BASE POLIURETANO ESPANSO

STRUTTURA

Il rivestimento è realizzato in poliuretano espanso supportato in alluminio grezzo sul lato inferiore ed in alluminio bugnato sul lato superiore.

LACCATURA

Il pannello di rivestimento è sottoposto a laccatura uniformante. La finitura è del tipo "lucido" oppure "opaco".

FINITURA LEGNO

Il pannello di rivestimento è sottoposto a finitura legno

Panels made out of a double aluminum sheet and an interspace support. Suitable for the exterior, they boast a compact and resistant structure, offering remarkable duration in time. Available in numerous RAL colors and wood-stained finishes.

STRUCTURAL ALUMINIUM MDF-BASED

STRUCTURE

The panelling is made of insulating MDF supported by a rough profile on the lower side and by a light alloy on the upper side.

LACQUERING

The panelling undergoes an evening lacquering. The finish is matt.

WOOD FINISH

The panelling undergoes a faux wood finishing.

STRUCTURAL THERMAL ALUMINIUM POLYURETHANE FOAM-BASED

STRUCTURE

The panelling is made of expanded polyurethane supported with raw aluminium on the lower side and in textured aluminium on the upper side.

LACQUERING

The panelling undergoes an evening lacquering. The finish is matt and feasible also in the glossy finish.

WOOD FINISH

The panelling undergoes wood colour painted finishing.

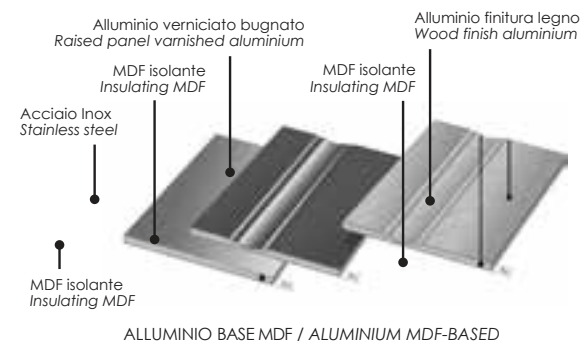

ALLUMINIO BASE MDF / ALUMINIUM MDF-BASED

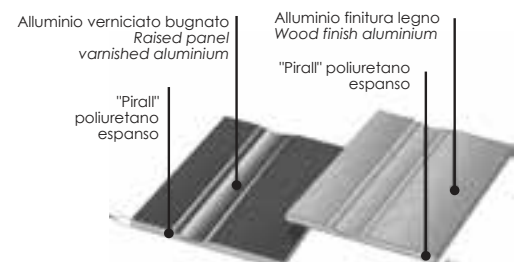

ALLUTERMICO BASE POLIURETANO ESPANSO
THERMAL ALUMINIUM POLYURETHANE FOAM-BASED

SERIE R

Alluminio Base MDF | Allutermico Base Poliuretano

MDF-based aluminium | Polyurethane foam-based thermal aluminium

* disponibile anche nella versione Inox



MOD. QC Liscio alluminio/aluminium *
MOD. 4u Liscio allutermico/thermal aluminium
Laccato RAL 6002 / Lacquered RAL 6002



MOD. 4a Abaco K alluminio/aluminium
MOD. 4v Abaco K allutermico/thermal aluminium
Laccato RAL 6002 / Lacquered RAL 6002



MOD. QD Aldebaran K alluminio/aluminium
MOD. 4w Aldebaran K Alfair K
Laccato RAL 6002 / Lacquered RAL 6002



MOD. QE Alfair K alluminio/aluminium
MOD. 4x Alfair K allutermico/thermal aluminium
Laccato RAL 6005 / Lacquered RAL 6005



MOD. QF Algenib K alluminio/aluminium
MOD. 4y Algenib K allutermico/thermal aluminium
Laccato RAL 6005 / Lacquered RAL 6005



MOD. QG Algenib KB alluminio/aluminium
MOD. 4z Algenib KB allutermico/thermal aluminium
Laccato RAL 6005 / Lacquered RAL 6005

SERIE R

Alluminio Base MDF | Allutermico Base Poliuretano

MDF-based aluminium | Polyurethane foam-based thermal aluminium



MOD. QH Algenib KC alluminio/aluminium
MOD. 8h Algenib KC allutermico/thermal alum.
Laccato RAL 7048 / Lacquered RAL 7048



MOD. QI Alizar K alluminio/aluminium
MOD. 7b Alizar K allutermico/thermal aluminium
Laccato RAL 7048 / Lacquered RAL 7048

SERIE R

Alluminio Base MDF | Allutermico Base Poliuretano

MDF-based aluminium | Polyurethane foam-based thermal aluminium



MOD. QJ Antares K alluminio/aluminium
MOD. 7c Antares K allutermico/thermal aluminium
Laccato RAL 8023
Lacquered RAL 8023



MOD. QK Aries K alluminio/aluminium
MOD. 7d Aries K allutermico/thermal aluminium
Laccato RAL 8023
Lacquered RAL 8023



MOD. QL Aries KB alluminio/aluminium
MOD. 7e Aries KB allutermico/thermal aluminium
Laccato RAL 8023
Lacquered RAL 8023



MOD. 4b Auriga K alluminio/aluminium
MOD. 7f Auriga K allutermico/thermal aluminium
Laccato RAL 8023
Lacquered RAL 8023



MOD. QN Castore K alluminio/aluminium
MOD. 7h Castore K allutermico/thermal aluminium
Laccato RAL 8023
Lacquered RAL 8023



MOD. 4c Echo K alluminio/aluminium
MOD. 7i Echo K allutermico/thermal aluminium
Laccato RAL 8023
Lacquered RAL 8023



MOD. 4d Elisir K alluminio/aluminium
MOD. 7j Elisir K allutermico/thermal aluminium
Laccato RAL 8023
Lacquered RAL 8023



MOD. 4e Eridano K alluminio/aluminium
MOD. 7k Eridano K allutermico/thermal alum.
Laccato RAL 8023
Lacquered RAL 8023

SERIE R

Alluminio Base MDF | Alltermico Base Poliuretano

MDF-based aluminium | Polyurethane foam-based thermal aluminium



MOD. QO Gemini K alluminio/aluminium

MOD. 7l Gemini K alltermico/thermal aluminium

Laccato RAL 8011

Lacquered RAL 8011



MOD. 4f Geo K alluminio/aluminium

MOD. 7m Geo K alltermico/thermal aluminium

Laccato RAL 8011

Lacquered RAL 8011

SERIE R

Alluminio Base MDF | Allutermico Base Poliuretano

MDF-based aluminium | Polyurethane foam-based thermal aluminium



MOD. 7P Icaro K alluminio /aluminium

MOD. 7n Icaro K allutermico/thermal aluminium

Laccato RAL 7040 / Lacquered RAL 7040



MOD. 4g Kalipso KD alluminio/aluminium

MOD. 7o Kalipso KD allutermico/thermal aluminium

Laccato RAL 7040 / Lacquered RAL 7040

SERIE R

Alluminio Base MDF | Allutermico Base Poliuretano

MDF-based aluminium | Polyurethane foam-based thermal aluminium



MOD. 4h Klio KB alluminio/aluminium

MOD. 7p Klio KB allutermico/thermal aluminium
Laccato RAL 7001 / Lacquered RAL 7001

MOD. 4i Libra K alluminio/aluminium

MOD. 7q Libra K allutermico/thermal aluminium
Laccato RAL 7001 / Lacquered RAL 7001

MOD. QQ Mira K alluminio/aluminium

MOD. 7r Mira K allutermico/thermal aluminium
Laccato RAL 7001 / Lacquered RAL 7001



MOD. QR Miranda K alluminio/aluminium

MOD. 7s Miranda K allutermico/thermal aluminium
Laccato RAL 7006 / Lacquered RAL 7006

MOD. QS Pegaso K alluminio/aluminium

MOD. 7t Pegaso K allutermico/thermal aluminium
Laccato RAL 7006 / Lacquered RAL 7006

MOD. QT Pegaso KB alluminio/aluminium

MOD. 7u Pegaso KB allutermico/thermal aluminium
Laccato RAL 7006 / Lacquered RAL 7006



MOD. QU Pegaso KM alluminio/aluminium

MOD. 7v Pegaso KM allutermico/thermal aluminium
Laccato RAL 7022 / Lacquered RAL 7022

MOD. QV Polaris K alluminio/aluminium

MOD. 7w Polaris K allutermico/thermal aluminium
Laccato RAL 7022 / Lacquered RAL 7022

MOD. QZ Perseo K alluminio/aluminium

MOD. 7x Perseo K allutermico/thermal alum.
Laccato RAL 7022 / Lacquered RAL 7022

SERIE R

Alluminio Base MDF | Allutermico Base Poliuretano

MDF-based aluminium | Polyurethane foam-based thermal aluminium



MOD. 4j Quasar K alluminio/aluminium
MOD. 7y Quasar K allutermico/thermal alum.
Laccato RAL 8011
Lacquered RAL 8011



MOD. QW Regolo KA alluminio/aluminium
MOD. 7z Regolo KA allutermico/thermal alum.
Laccato RAL 8011
Lacquered RAL 8011



MOD. QX Regolo KB alluminio/aluminium
MOD. 8b Regolo KB allutermico/thermal alum.
Laccato RAL 8011
Lacquered RAL 8011



MOD. 4k Regolo KC alluminio/aluminium
MOD. 8c Regolo KC allutermico/thermal alum.
Laccato RAL 8011
Lacquered RAL 8011



MOD. 4l Regolo KD alluminio/aluminium
MOD. 8d Regolo KD allutermico/thermal alum.
Laccato RAL 8011
Lacquered RAL 8011



MOD. 4m Sirio K alluminio/aluminium
MOD. 8e Sirio K allutermico/thermal alum.
Laccato RAL 8011
Lacquered RAL 8011



MOD. QY Titano K alluminio/aluminium
MOD. 8f Titano K allutermico/thermal alum.
Laccato RAL 8011
Lacquered RAL 8011



MOD. 4n Urania K alluminio/aluminium
MOD. 8g Urania K allutermico/thermal alum.
Laccato RAL 8011
Lacquered RAL 8011



MOD. bz Rigo HG allutermico/thermal alum.
Laccato RAL 8011
Lacquered RAL 8011

SERIE R

Alluminio Base MDF | Allutermico Base Poliuretano

MDF-based aluminium | Polyurethane foam-based thermal aluminium

SCEGLI LA FINITURA

SELECT THE FINISH

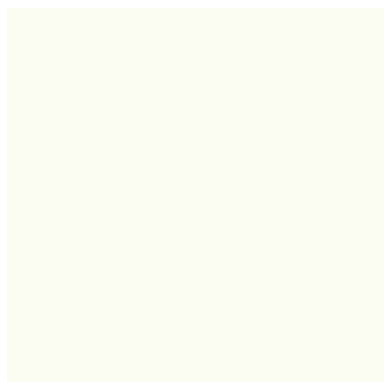

Laccato avorio
Lacquered ivory

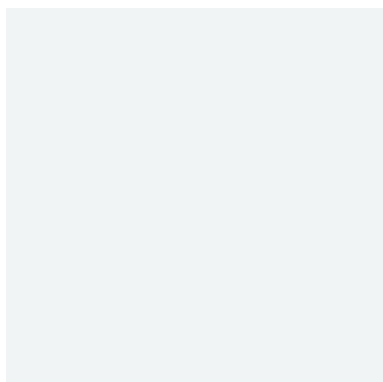

Laccato bianco ghiaccio
Lacquered ice white

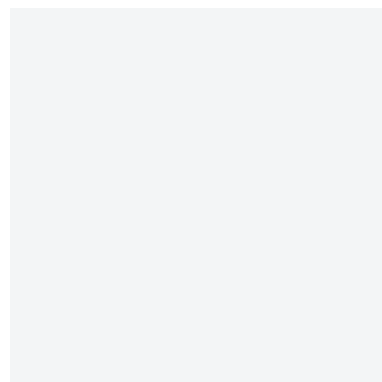

Laccato bianco neve
Lacquered snow white

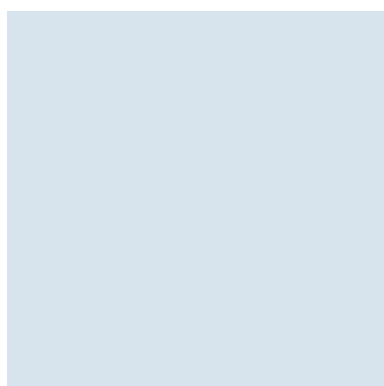

Laccato celeste
Lacquered light blue



Laccato rosso
Lacquered red



Laccato verde
Lacquered green



Laccato verde chiaro
Lacquered light green



Laccato nero
Lacquered black



Laccato RAL a scelta
Choice of lacquered RAL

PREDISPOSIZIONE FINESTRATURA

Alluminio Base MDF | Allutermico Base Poliuretano

*MDF-based aluminium | Polyurethane foam-based thermal aluminium
predisposed for windowpanes*

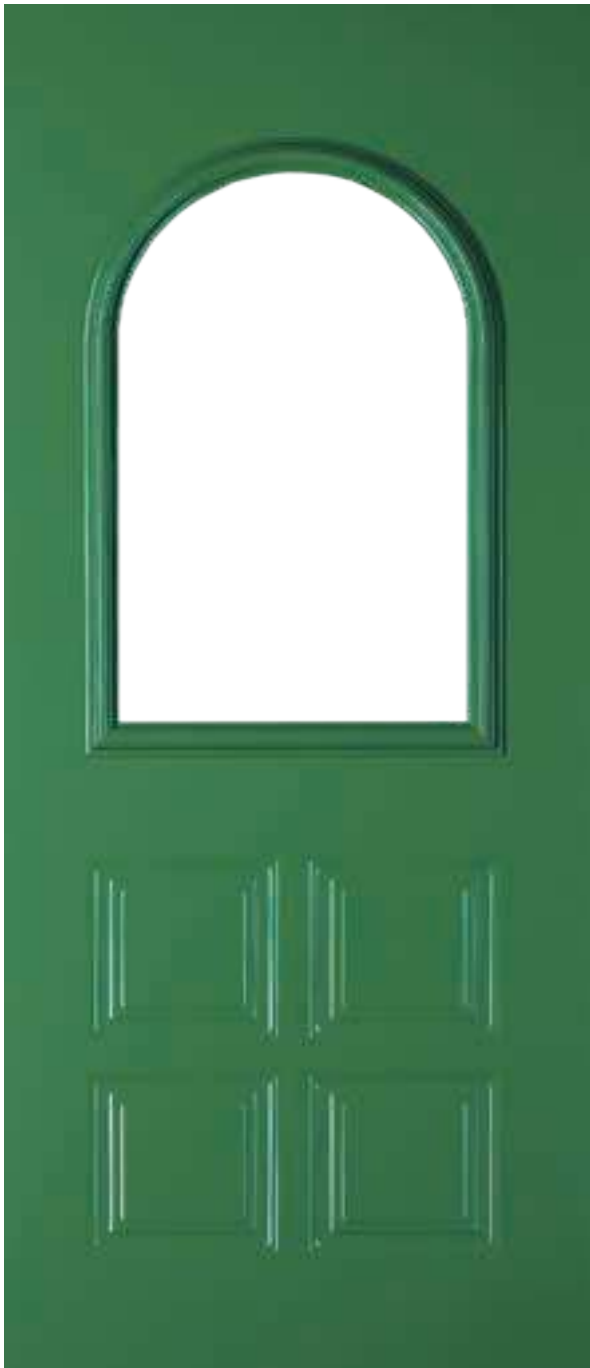

MOD. RJ Sirio K1 alluminio/aluminium

MOD. fw Sirio K1 allutermico/thermal aluminium

Laccato RAL5010 / Lacquered RAL5010

SCEGLI LA TUA FINITURA A PAG 35 / SELECT YOUR FINISH ON PAGE 35

SCEGLI IL TUO VETRO NEL VOLUME NUMERO 7 / SELECT YOUR GLASS IN VOLUME NUMBER 7



IDROSKIN

IDROSKIN



Pannelli ideali per l'esterno, grazie alla capacità di resistere nel tempo agli agenti atmosferici e di respingere i raggi ultravioletti

CARATTERISTICHE STRUTTURALI

Pellicola in PVC garantita 5 anni al viraggio del sole anche a temperature elevate: respinge il 40% dei raggi ultravioletti contribuendo quindi a ridurre il calore assorbito dalla porta metallica. Pellicola in PVC anche nel lato posteriore a filo del bordo onde evitare che flussi di umidità possano intaccare il supporto in MDF idrorepellente.

PULIZIA

Pulizia consentita solo con acqua e ammoniacca.

TUTTI I MODELLI PANTOGRAFATI DA 14 mm PRESENTI NEL VOLUME 4 SONO DISPONIBILI RIVESTITI IN IDROSKIN

Per i modelli en, eo, ep, eq il senso della venatura è nella stessa direzione e non incrociato

Ideal outdoor panels, thanks to their ability to withstand atmospheric agents and to repel ultraviolet rays over time.

STRUCTURAL FEATURES

PVC film guaranteed for 5 years against sun damage. The bonding of the PVC film was tested in the Catas lab, even at high temperatures: it repels 40% of ultraviolet rays, thus reducing the amount of heat absorbed by the metal door. PVC film also on the back side and edges, to prevent moisture from affecting the water-repellent MDF-based support.

CLEANING

Can only be cleaned with water and ammonia.

ALL 14-MM PANTOGRAPHED MODELS LISTED IN VOLUME 4 ARE AVAILABLE WITH IDROSKIN \COVERING

For en, eo, ep, eq models the direction of the grain is in the same direction and not crossed



SCEGLI LA FINITURA
SELECT THE FINISH



Achatgrau grigio RAL 7038



Alluminium



American Brown RAL 8025



Anteak



Antracite RAL 7016



Azzurro RAL 5007

SCEGLI LA FINITURA
SELECT THE FINISH



Bianco venato RAL 9010



Black Cherry



Corten Rost Mat



Creme Weiss



Grigio chiaro RAL 7004



Grigio luce RAL 7035



Grigio scuro RAL 7005



Moreike

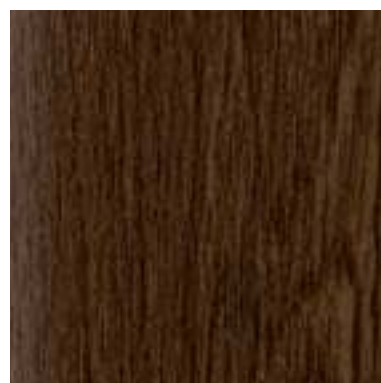

Noce Nussbaum

SCEGLI LA FINITURA
SELECT THE FINISH



Pepper Oak



Quartz Grau RAL 7039



Roccia



Rovere gold

SCEGLI LA FINITURA
SELECT THE FINISH



Rovere Sbiancato



Siena PL



Rosso Vino RAL 3005



Siena PN



Siena PR



Titanio



Verde chiaro RAL 6005



Verde scuro 6009



White Tecnofil



Sentry 1 mod. Natalie, fasce Iron corten e Iron Moss
Sentry 1 mod. Natalie, bands Iron Corten and Iron Moss

NEW CERAMIC LINE

NEW CERAMIC LINE



Pannelli ideali per l'esterno, grazie alla capacità di resistere nel tempo agli agenti atmosferici.

STRUTTURA

Pannello stratificato in gres porcellanato

SUPERFICIE

Resistente ai prodotti pulenti domestici
Resistente agli acidi e alcali a bassa concentrazione
Resistente alle macchie
Resistente ai graffi superficiali.

Ideal outdoor panels, thanks to their ability to withstand atmospheric agents over time.

STRUCTURAL FEATURES

Laminated porcelain stoneware panels

*Resistant to household cleaning products
Resistant to low-concentration acids and alkalis
Stain-resistant
Resistant to surface scratches*



Ceramic Line

Ceramic Line

**PERSONALIZZA LA PORTA
SCEGLIENDO
LA FINITURA
DELLE FASCE**

vedi a pag. 16

**CUSTOMIZE THE DOOR
BY CHOOSING
THE FINISHING
OF THE BANDS**

on page 16



MOD. Sophie

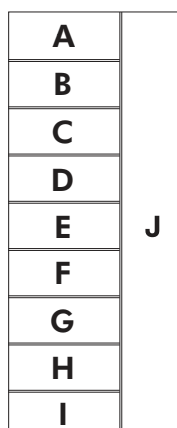

MOD. Vincent

J - il pannello può essere gres o alluminio

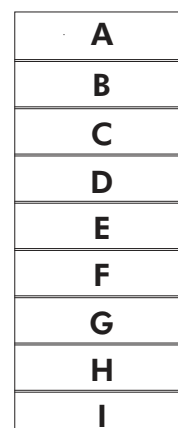

MOD. Mathieu

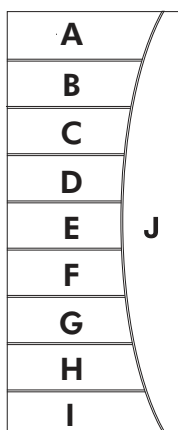

MOD. Monique

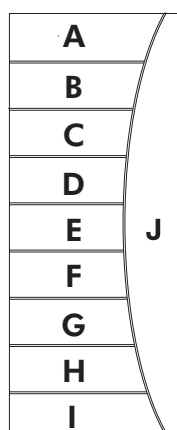

MOD. Natalie

J - il pannello è in alluminio

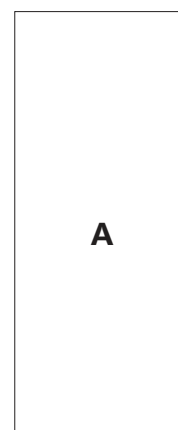

MOD. Isabelle



MOD. Sophie
Fasce: Pulpis e Phedra
Bands: *Pulpis and Phedra*



MOD. Vincent
Fasce: Iron Copper e Iron Moss
Bands: *Iron Copper and Iron Moss*

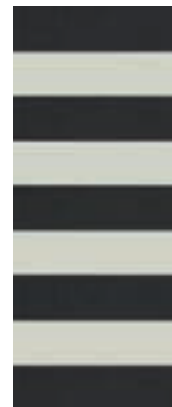

MOD. Mathieu
Fasce: Basalt Black e Perla
Bands: *Basalt Black and Perla*

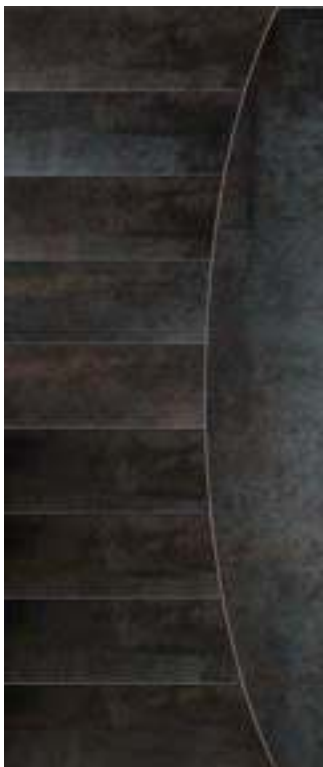

MOD. Monique
Fasce: Iron Copper e Iron Grey
Bands: *Iron Copper and Iron Grey*



MOD. Nathalie
Fasce: Iron corten e Iron Moss
Bands: *Iron Corten and Iron Moss*



MOD. Isabelle
Pulpis

Ceramic Line
Ceramic Line



MOD. Sophie
Fasce: Cement e Calacatta
Bands: Cement and Calacatta



MOD. Sophie
Fasce: Perla e Arena
Bands: Perla and Arena



MOD. Sophie
Fasce: Iron Corten e Iron Copper
Bands: Iron Corten and Iron Copper



MOD. Vincent
Fasce: Calacatta e alluminio
Bands: Calacatta and aluminium



MOD. Vincent
Fasce: Nero e Nieve
Bands: Nero and Nieve



MOD. Vincent
Fasce: Nero e Pulpis
Bands: Nero and Pulpis



MOD. Mathieu
Fasce: Pulpis e Nieve
Bands: Pulpis and INieve

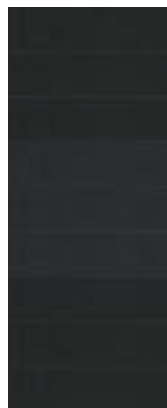

MOD. Mathieu
Fasce: Basalt Black e Nero
Bands: Basalt Black and Nero

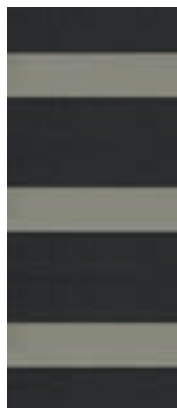

MOD. Mathieu
Fasce: Basalt Black e Phedra
Bands: Basalt Black and Phedra



MOD. Monique
Fasce: Iron Copper e Iron Corten
Bands: Iron Copper and Iron Corten



MOD. Monique
Fasce: Cement e Calacatta
Bands: Cement and Calacatta



MOD. Monique
Fasce: Pulpis e Phedra
Bands: Pulpis and Phedra



MOD. Nathalie
Fasce: Phedra e Nieve
Bands: Phedra and Nieve



MOD. Nathalie
Fasce: Iron Moss e Iron Copper
Bands: Iron Moss and Iron Copper



MOD. Nathalie
Fasce: Pulpis e Arena
Bands: Pulpis and Arena



MOD. Isabelle
Calacatta

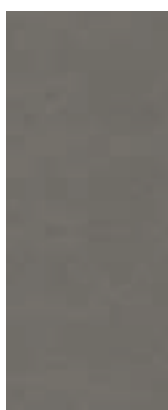

MOD. Isabelle
Cement



MOD. Isabelle
Iron Copper

SCEGLI LA FINITURA
SELECT THE FINISH



Arena Satin



Basalt Black Satin



Calacatta Silk



Cementin Satin

SCEGLI LA FINITURA
SELECT THE FINISH



Iron Copper Satin



Iron Corten Satin



Iron Grey Satin

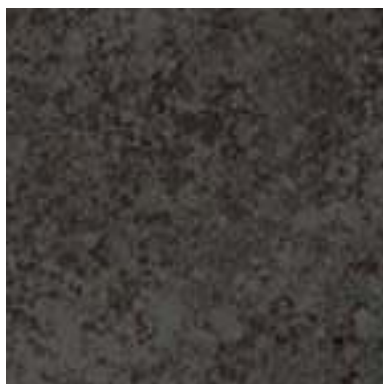

Iron Moss Satin



Nero Satin

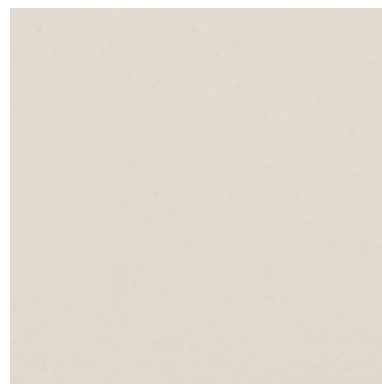

Nieve Satin

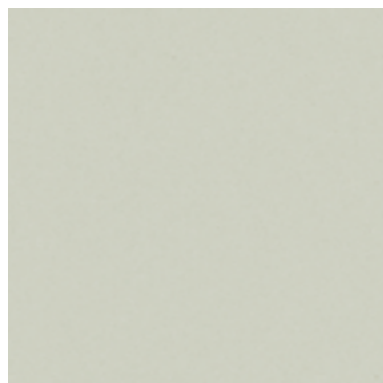

Perla Satin



Phedra Satin

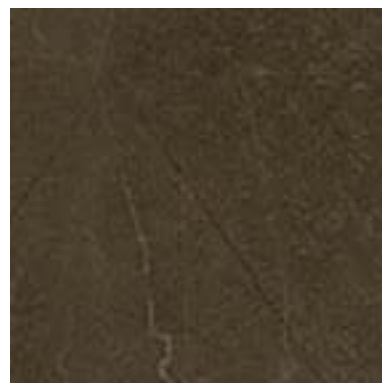

Pulpis Silk